

Ratchet Lever

LSB-B-680

Operating, Maintenance &
Parts Manual

LSB-B Series

**3/4 to 6 Ton
Model Numbers**

LSB1500B

LSB3000B

LSB6000B

LSB12000B



Follow all instructions and warnings for inspecting, maintaining and operating this hoist.

The use of any hoist presents some risk of personal injury or property damage. That risk is greatly increased if proper instructions and warnings are not followed. Before using this hoist, each operator should become thoroughly familiar with all warnings, instructions, and recommendations in this manual. Retain this manual for future reference and use.

Forward this manual to the hoist operator. Failure to operate the equipment as directed in the manual may cause injury.

Should you have any questions regarding this product, please call Coffing Hoists at **(314) 869-7200**.

Before using the hoist, fill in the information below:

Model No. _____

Serial No. _____

Purchase Date _____

COFFING[®]
HOISTS

Distributed by Tri-State Equipment Company Inc.
sales@tsoverheadcrane.com
www.tsoverheadcrane.com
Tel: (314) 869-7200

SAFETY PRECAUTIONS

Each Coffing LSB-B Manually Operated Lever Chain Hoist is built in accordance with the specifications contained herein and at the time of manufacture complies with our interpretation of applicable sections of *American Society of Mechanical Engineers Code (ASME) B30.21 and the *American National Standards Institute ANSI/ASME HST-3M. *Copies of this Standard can be obtained from ASME Order Department, 22 Law Drive, Box 2300, Fairfield, NJ 07007-2300, U.S.A.

WARNING

Improper operation of a hoist can create a potentially hazardous situation which, if not avoided, could result in death or serious injury. To avoid such a potentially hazardous situation, the operator shall:

1. **NOT** operate a malfunctioning or unusually performing hoist.
2. **NOT** operate the hoist until you have thoroughly read and understood the manufacturer's Operating and Maintenance Instructions or Manuals.
3. **NOT** operate a hoist which has been modified without the manufacturer's approval or certification to be in conformity with applicable OSHA regulations.
4. **NOT** lift or pull more than rated load of the hoist.
5. **NOT** use damaged hoist or hoist that is NOT working properly.
6. **NOT** use hoist with twisted, kinked, damaged, or worn load chain.
7. **NOT** operate with any lever extension (cheater bar).
8. **NOT** attempt to "free-chain" the hoist while a load is applied.
9. **NOT** use the hoist to lift, support, or transport people.
10. **NOT** lift loads over people and shall make sure all personnel remain clear of the supported load.
11. **NOT** attempt to lengthen the load chain or repair damaged load chain.
12. Protect the hoist's load chain from weld splatter or other damaging contaminants.
13. **NOT** operate hoist when it is restricted from forming a straight line from hook to hook in the direction of loading.
14. **NOT** use load chain as a sling or wrap load chain around load.
15. **NOT** apply the load to the tip of the hook or the hook latch.
16. **NOT** apply load unless load chain is properly seated in the chain wheel(s) or sprocket(s).
17. **NOT** apply load if bearing prevents equal loading on all load supporting chains.
18. **NOT** operate beyond the limits of the load chain travel.
19. **NOT** leave load supported by the hoist unattended unless specific precautions have been taken.
20. **NOT** allow the chain or hook to be used as an electrical or welding ground.
21. **NOT** allow the chain or hook to be touched by a live welding electrode.
22. **NOT** remove or obscure the warnings on the hoist.
23. **NOT** operate a hoist which has NOT been securely attached to a suitable support.
24. **NOT** operate a hoist unless load slings or other approved single attachments are properly sized and seated in the hook saddle.
25. **NOT** lift loads that are NOT balanced and that the holding action is NOT secure, taking up slack carefully.
26. **NOT** operate a hoist unless all persons are and remain clear of the supported load.
27. Report malfunctions or unusual performances of a hoist, after it has been shut down until repaired.
28. **NOT** operate a hoist which the safety placards or decals are missing or illegible.
29. Be familiar with operating controls, procedures, and warnings.

SAFETY PRECAUTIONS (Continued)

 **CAUTION**

Improper operation of a hoist can create a potentially hazardous situation which, if not avoided, could result in minor or moderate injury. To avoid such a potentially hazardous situation, the operator shall:

1. Maintain a firm footing or be otherwise secured when operating the hoist.
2. Check brake function by tensioning the hoist prior to each lift or pulling operation.
3. Use hook latches. Latches are to retain slings, chains, etc. under slack conditions only.
4. Make sure the hook latches are closed and not supporting any parts of the load.
5. Make sure the load is free to move and will clear all obstructions.
6. Avoid swinging the load or hook.
7. Avoid lever “fly-back” by keeping a firm grip on the lever until operating stroke is completed and the lever is at rest.
8. Inspect the hoist regularly, replace damaged or worn parts, and keep appropriate records of maintenance.
9. Use the hoist manufacturer’s recommended parts when repairing the unit.
10. Lubricate load chain per hoist manufacturer’s recommendations.
11. **NOT** use the hoist load limiting or warning device to measure load.
12. **NOT** operate except with manual power.
13. **NOT** permit more than one operator to pull on lever at the same time. More than one operator is likely to cause hoist overload.
14. **NOT** allow your attention to be diverted from operating the hoist.
15. **NOT** allow the hoist to be subjected to sharp contact with other hoists, structures, or objects through misuse.
16. **NOT** adjust or repair the hoist unless qualified to perform such adjustments or repairs.
17. **NOT** expose the unit to high temperatures in excess of 200°F.

TABLE OF CONTENTS

Safety Precautions.....	1-2
Hoist Specifications.....	3
Application Information.....	3
Safety Information.....	4
Operation.....	5
Maintenance.....	6
Optional Overload Protection.....	7
Trouble Shooting.....	8
Inspection & Maintenance Check List.....	9
Inspector’s Report.....	10
Lubrication Schedule.....	10
Replacement Parts List for .75 & 1.5 Ton Models.....	11-12
Replacement Parts List for 3 & 6 Ton Models.....	13-14
Warranty.....	Back Cover

HOIST SPECIFICATIONS

Coffing Lever Hoists are made of the best selected materials to provide long dependable service for users. Coffing Lever Hoists are manufactured and processed through up to date streamlined production facilities by skilled engineers under strict quality control. All lever hoists are tested per ASME B30.21 before leaving our factory. Refer to the back cover for Certification Statement.

Table 1 - Hoist Specifications

Rated Capacity (tons)	Std. Lift (ft)	Chain dia. x falls	Minimum Distance Between Hooks (in)	Pull on lever to lift full load (lbs)	Length of operating handle (in)	Net Weight (lbs)	Test Load (tons)
.75	5	ø5.6mmx1	11 ⁷ / ₁₆	46	9 ¹ / ₄	12	1.125
1.5	5	ø7.1mmx1	13	59	14 ⁹ / ₁₆	21	2.25
3	5	ø9mmx1	16 ¹⁵ / ₁₆	75	14 ⁹ / ₁₆	35	4.5
6	5	ø9mmx2	22 ³ / ₄	76	14 ⁹ / ₁₆	67	9.0

The design, materials and specifications are subject to change for improvements without notice.

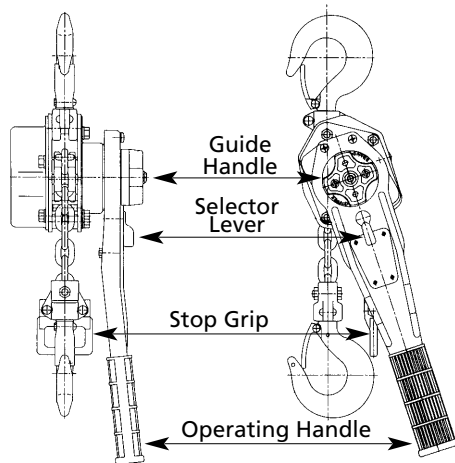

Figure 1 - Lever Hoist

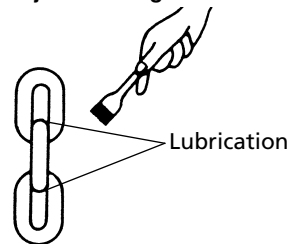

Figure 2 - Chain Lubrication

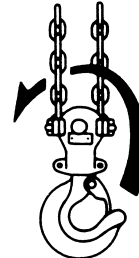

Figure 3 - Correcting Chain Twist

APPLICATION INFORMATION

1. Inspect carefully for any damage that may occur during shipping. Check for loose, missing, or damaged parts.
2. Lubricate the load chain along the whole length with machine oil (See Figure 2).
3. Examine the load chain to ensure that there is no twist. When your lever hoist is a 6 ton that lifts on 2 falls of load chains, twists can arise from the bottom hook being accidentally turned over through the load chains (See Figure 3).
4. Confirm that the supporting structure is strong enough to support the full rated capacity of the lever hoist with a generous factor of safety.

SAFETY INFORMATION

1. Keep the load within the rated capacity marked on the hoist's lever. An excess load may lead to an accident. The lever hoist is overloaded when the handle effort indicated in the standard specifications is exceeded (See Table 1).
2. Before operating, lift and lower the load about 4" and test the brake system. Ineffective braking may lead to an accident.
3. Loads must be lifted as slowly as possible. Load swinging and abrupt shocks will impose on the lever hoist excessive burdens that may more than double the weight of the load.
4. Extreme temperatures will affect the durability of the lever hoist. In subzero temperatures loads must be lifted and lowered very slowly and carefully.

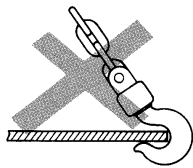

Figure 4 - Incorrect Attachment

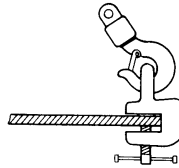

Figure 5 - Correct Attachment

5. When hooking, the load must be applied squarely to the center of the hook and the hook must not come loose during operation. NEVER USE THE HOOK DIRECTLY ON A LOAD (See Figure 4). Use the attachments as shown in Figure 5.

Figures 6 through 9 show improper hooking methods, which may cause the hook to elongate or bend. These hooking methods may also obstruct the load chain flow to the load sheave and prevent the lever hoist from operating properly.

6. Never run the chain out too far. When the lever hoist is run out beyond the range of lift, a dangerous excessive load will be imposed on the load chain, stop grip and gearing.
7. The selector lever must be set to the "UP" position when the lever hoist is under a load during hoisting or pulling.
8. Lifting a load with two lever hoists is not recommended. If the job is unavoidable, keep the load well within the total rated capacity of each lever hoist to avoid overloading one or both of the hoists; lift with exceptional care while maintaining proper balance, angle and lifting speed.

CAUTION

In applications similar to Figures 6 through 9, be sure to use the correct slings and attachments to ensure safe operation and long life of the lever hoist.

Figure 6

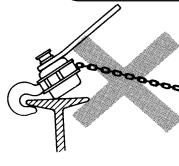

Figure 7

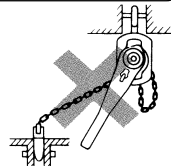

Figure 8

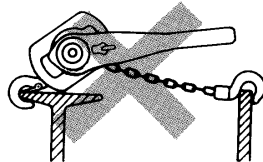

Figure 9



9. Do not throw or drop the lever hoist from high places; do not drag the lever hoist in transportation. Doing so may cause damage that may lead to an accident.
10. Never leave or store the lever hoist with the brake system locked. Loosen the brake system by operating the lever hoist as if lowering a load.
11. Always service and repair the lever hoist after use. Thoroughly clean the dust or if used in the rain, wipe off the dirt and moisture and lubricate the lever hoist to prevent rust.
12. Inspect the hooks and load chain for bends and any other types of defects. Also check to see if the hooks rotate. If any defect is found, replace the defective component before using the lever hoist again.

OPERATION

HOISTING (PULLING) AND LOWERING (RELEASING) (Figure 1)



1. Hoisting (Pulling)

Set the selector lever to the “UP” position. Take up the slacked load chain by turning the guide handle clockwise. Next, manipulate the operating handle clockwise.
2. Lowering (Releasing)

Set the selector lever to the “DOWN” position. Manipulate the operating handle counterclockwise. When there is no load on the lever hoist, the load chain can be slacked by turning the guide handle counterclockwise.

FREE-CHAINING (Figure 1)

This operation is for making quick large adjustments of the load chain length without load. Set the selector lever to the “N” position and pull the load chain out in the desired direction. Free-chaining will not be possible during the following conditions:

1. When the lever hoist is under a load.
2. When the guide handle is in contact with something and not rotating freely.
3. When the brake has locked from a large or abrupt load:

Turn the guide handle 45° counterclockwise to unlock the brake.
4. When the brake is locked:

The brake can be unlocked by setting the selector lever to the “DOWN” position and manipulating the operating handle counterclockwise.

RESETTING (Figure 1)

The lever hoist will automatically change from the free-chaining condition to the brake locked condition when a load is applied. Apply the load with one of the following two methods:

- a. Turn the guide handle clockwise until the brake locks from the force of the load.
- b. Pull firmly on the stop grip until the brake locks from the force of the load (See Photo 1).

Next, turn the selector lever to the “UP” position and hoist or pull by manipulating the operating handle.

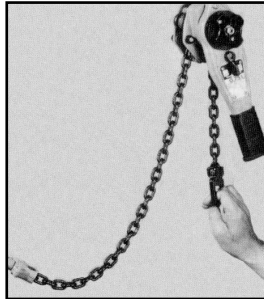

Photo 1 - Slack Chain Take-Up

MAINTENANCE

The lever hoist is designed and made to withstand heavy-duty materials handling operations, but wear and damage are unavoidable after a long period of use and depending on the place and method of use. This is why we suggest that your company or workshop adapt a periodic inspection program for the lever hoist.

1. Never leave the lever hoist in a damp environment or damp weather such as rain. Always store the lever hoist in a dry airy area.
2. Proper lubrication will help lengthen the life of the lever hoist. Before storing, check to see if the lever hoist is well lubricated. Be especially sure that the moving parts such as gears and bearings are well lubricated.

LOAD CHAIN

Load chains worn-out or elongated beyond the permissible dimensions must be replaced at once. Replace the entire load chain immediately even if one link of the load chain is extensively worn-out, elongated or damaged.

HOOKS

If the hook opening is elongated beyond the permissible dimension, the hook is dangerously deformed and must be replaced at once. No deformation of the hook should arise when the lever hoist is used and maintained properly.

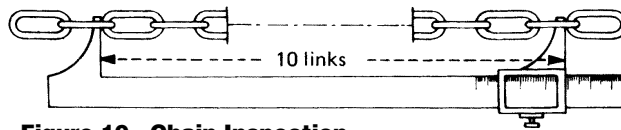

Figure 10 - Chain Inspection

Hoist Capacity (tons)	Diameter (ømm)	Standard (in.)	Limit (in.)
.75	5.6	6.732	6.866
1.5	7.1	8.346	8.511
3 & 6	9	10.709	10.923

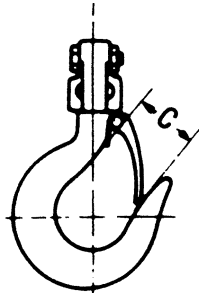

Figure 11 - Hook Inspection

Hoist Capacity (tons)	Standard Size (in.)	"C" Dimension Limit (in.)
.75	1 ³ / ₁₆	1 ⁵ / ₁₆
1.5	1 ¹³ / ₃₂	1 ⁹ / ₁₆
3	1 ²¹ / ₃₂	1 ¹³ / ₁₆
6	2 ³ / ₆₄	2 ¹ / ₄

NOTE: Limit *C (in.) are the maximum permissible dimensions of the hooks, which are about 10% wider than the standard hook openings.

OPTIONAL OVERLOAD PROTECTION

A standard LSB-B Lever Hoist can be converted to a unit with the overload protection by replacing Reference No. 14 (See Figures 15 & 16) with Reference No. 80 (See Figure 12). Refer to chart below for the appropriate load limiter for your capacity hoists.

Figure 12 - Overload Protection Device

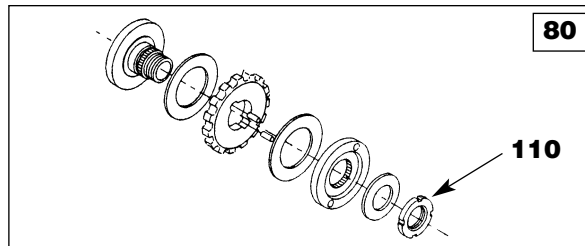

Ref. No.	Description	.75 Ton Part No.	1.5 Ton Part No.	3 Ton Part No.	6 Ton Part No.	Qty
80	Overload Protection Device	IRB5080U	KRB5080U	NRB5080U	QRB5080U	1

The load limiter may require adjustment when it slips at or below rated load. Please refer to chart below for the correct torque setting for the load limiter. Only adjust the load limiter by Reference No. 110. If the load limiter cannot be corrected by adjusting the torque setting or if any of the parts are damaged then the load limiter must be replaced. A special tool is required to adjust Item 110 properly (Contact Factory).

Table 2 - Torque Range for Item 110

Hoist Model	Torque Range (foot-lbs)
LSB1500B	28 - 32
LSB3000B	59 - 66
LSB6000B	77 - 85
LSB12000B	77 - 85

NOTE: Excessive torque will damage the load limiter and could cause equipment damage or personal injury.

TROUBLE SHOOTING

— Probable Cause —

— Remedy —

Probable Cause	Remedy
Slip caused by ineffective braking.	
<ol style="list-style-type: none"> 1. Worn-out friction discs. 2. Excessive oil on the braking surface. 3. Incorrect assembly of the brake system. 	<ol style="list-style-type: none"> 1. Replace with new friction discs. 2. Disassemble and clean. 3. Assemble correctly. (See Figures 15 & 16)
Load dropped while lowering.	
<ol style="list-style-type: none"> 1. Damaged friction discs. 2. Foreign matters in the braking system. 	<ol style="list-style-type: none"> 1. Replace with new ones. 2. Disassemble and clean.
Jammed operating handle.	
Over-tightening of the brake.	Operate the lever hoist as if lowering a load.
Noises during hoisting and lowering operation.	
Wear or deformation of the load chain and load sheave.	Replace with new parts.
Operating handle becomes difficult to operate during lifting or lowering operation.	
<ol style="list-style-type: none"> 1. Over-hoisting or over-lowering. 2. Twist in the load chain causing it to get caught between load sheave and load chain guide. 	<ol style="list-style-type: none"> 1. Operate the hoist in opposite direction. 2. Operate the hoist in opposite direction and remove the twist from the load chain.

NOTE: Refer to Figures 15 & 16 for parts lists.

**INSPECTION AND MAINTENANCE CHECK LIST
LEVER OPERATED CHAIN HOIST**

Type of Hoist _____ Capacity (Tons) _____
 Location _____ Original Installation Date _____
 Manufacturer _____ Manufacturer's Serial No. _____

Item	Frequency of Inspection			Possible Deficiencies	OK	Action Req'd
	Frequent		Periodic			
	Daily	Monthly	1-12 Mo.			
Load Chain	*	*	*	Inadequate lubrication, excessive wear or stretch, cracked, damaged or twisted links, corrosion or foreign substance		
Hooks	*	*	*	Excessive throat opening, bent or twisted more than 10°, damaged hook latch, wear, chemical damage, cracks		
Hook Retainers	*	*	*	Worn or damaged nuts, pins, washers, collars used to secure hook in load block or housing		
Ratchet Handle Pawl & Load Pawl			*	Wear, cracks, broken teeth Wear, cracks or binding		
Pawl Springs			*	Breaks, corrosion, loss of tension		
Retaining Rings			*	Missing or loss of retention		
Pawl Stud			*	Excessive wear, pawl retention, looseness		
Sheave, Pinion Shaft, Chain Attachments			*	Distortion, cracks, excessive wear, damaged threads, build up of foreign substances		
Gearing			*	Inadequate lubrication, distortion, cracks, worn or broken teeth		
Bearings, Shafts			*	Inadequate lubrication, distortion, cracks, excessive wear		
Housing, Load Block, Outrigger, Hook Swivels			*	Cracks, distortion, loose bolts, nuts or rivets. Internal build up of foreign substances		
Nuts, Bolts, Rivets			*	Looseness, stripped or damaged threads		
Supporting Structure			*	Damage or wear which restricts ability to support imposed loads		
Capacity Plate & Decals			*	Missing, damaged or illegible		

NOTE: Refer to Maintenance and Inspection Sections of the Hoist-Maintenance Manual for further details.

FREQUENCY OF INSPECTION

Frequent — Indicates items requiring inspection daily to monthly. Daily inspections may be performed by the operator if properly designated.

Periodic — Indicates items requiring inspection monthly to yearly. Inspections to be performed by or under the direction of a properly designated person. The exact period of inspection will depend on frequency and type of usage. Determination of this period will be based on the user's experience. It is recommended that the user begin with a monthly inspection and extend the periods to quarterly, semi-annually or annually based on user's monthly experience.

Figure 13A — Recommended Inspection and Maintenance Check List

NOTE: This inspection and maintenance check list is in accordance with our interpretation of the requirements of the Safety Standard for Lever Hoists ASME B30.21 . It is, however, the ultimate responsibility of the employer/user to interpret and adhere to the applicable requirements of this safety standard.

INSPECTOR'S REPORT			
ITEM	REMARKS (LIST DEFICIENCIES AND RECOMMENDED ACTION)		
Inspector's Signature	Date Inspected	Approved by	Date

Figure 13B — Recommended Inspector's Report

RECOMMENDED LUBRICATION SCHEDULE* COFFING LEVER OPERATED CHAIN HOIST					
FIGURE NUMBERS	COMPONENT	TYPE OF LUBRICANT	TYPE OF SERVICE AND FREQUENCY OF LUBRICATION		
			HEAVY	NORMAL	INFREQUENT
See Figures 15 & 16	Load Chain	SAE 20-30 machine oil	Daily	Weekly	Monthly
See Figures 15 & 16	Load Pawl Shaft, Pinion Shaft, Gear & Bearings, Pinion & Gear Teeth	Multi-purpose Lithium base bearing grease	At periodic inspection (see Figure 13A)		
See Figures 15 & 16	Bottom Block Shaft, Bearing & Hook Swivel	SAE 20-30 machine oil	Monthly	Yearly	Yearly
(*) This lubrication schedule is based on a hoist operating in normal environmental conditions. Hoists operating in adverse atmospheres containing excessive heat, corrosive fumes or vapors, abrasive dust, etc., should be lubricated more frequently.					

CAUTION - DO NOT LUBRICATE BRAKE AREA OF HOIST.

Figure 14 — Recommended Lubrication Schedule

Figure 15 - .75 & 1.5 Ton Models

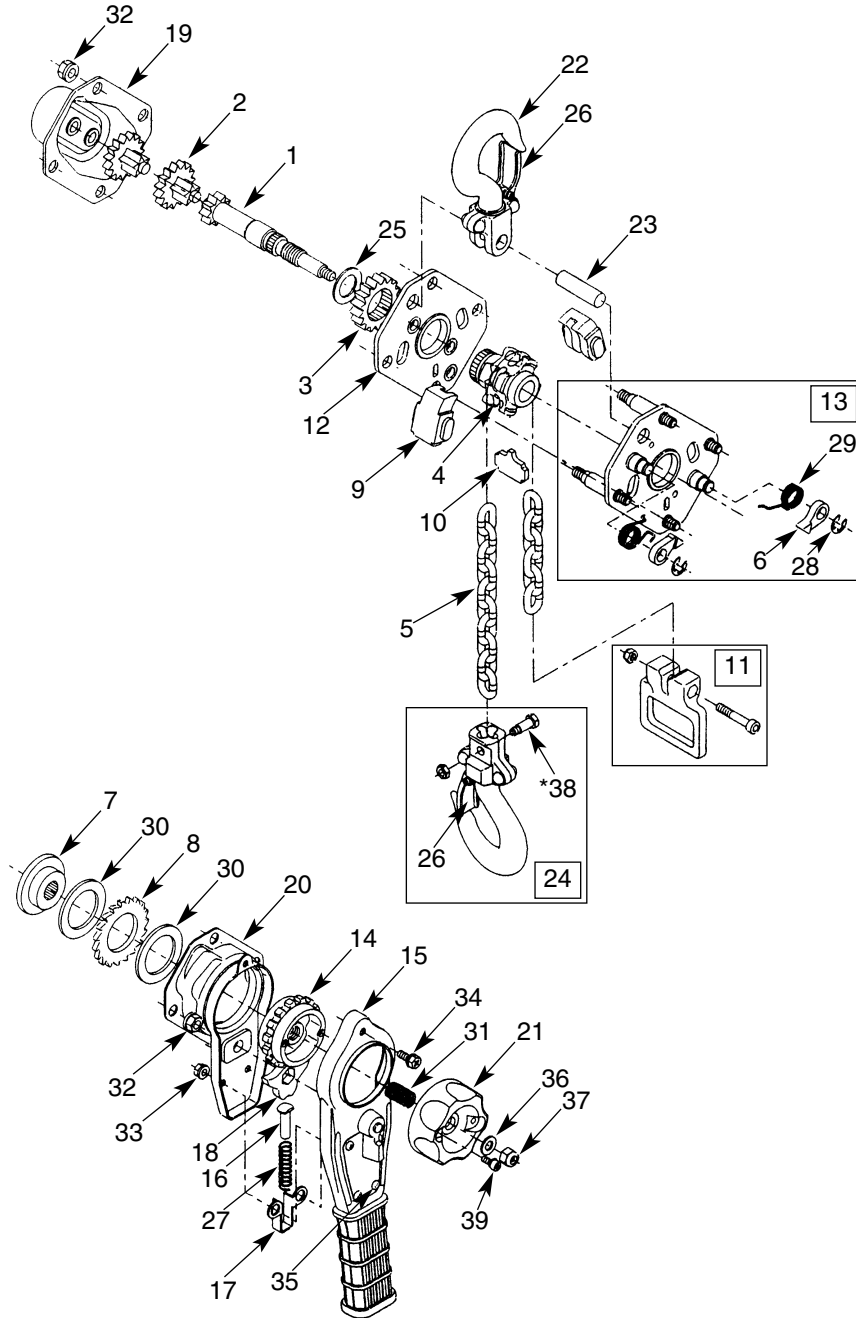

Ref. No.	Description	.75 Ton Part No.	1.5 Ton Part No.	Qty
1	Pinion Shaft	IRB5001	KRB5001	1
2	Pinion with Pinion Gear	IRB4002T	KRB4002T	2
3	Load Gear	IRB4004	KRB5004	1
4	Load Sheave	IRB5005	KRB5005	1
†5	Load Chain	T56	V71	1
6	Pawl	IRB5007	KRB5007	2
7	Disc Hub	IRB5008	KRB5008	1
8	Ratchet Wheel	IRB5009	KRB5009	1
9	Chain Guide	IRB5012	KRB5012	2
10	Stripper	IRB5015	KRB5015	1
11	Stop Grip	IRB40062T	KRB40062T	1
12	Gear Side Plate	IRB5018T	KRB5018T	1
13	Handle Side Plate	IRB5020U	KRB5020U	1
14	Disc Nut	IRB5023	KRB5023	1
15	Operating Handle	IRB5024T	KRB5024T	1
16	Spring Shaft	IRB4030	IRB3030	1
17	Shaft Base	IRB4031	IRB3031	1
18	Handle Pawl	GRB5032	KRB5032	1
19	Gear Cover	IRB5037	KRB5037	1
20	Ratchet Cover Assembly	IRB5040	KRB5040	1
21	Guide Handle	IRB5042	IRB5042	1
22	Top Hook Assembly	IRB5048U	KRB5048U	1
23	Yoke Pin	IRB5051	KRB5051	1
24	Bottom Hook Assembly	IRB5053U	KRB5053U	1
25	Collar for Pinion Shaft	IRB5059	IRB5059	1
26	Hook Latch Assembly	GRB5074T	KRB5074T	2
27	Change Over Spring	IRB4101	IRB3116	1
28	E-Ring	SRE8	SRE9	2
29	Pawl Spring	IRB5104	KRB5104	2
30	Brake Lining	IRB5105	KRB5105	2
31	Free-Chaining Spring	IRB5106	KRB5106	1
32	Spring Nut	HSN1M8	HSN1M8	8
33	Spring Nut	HSN1M6	HSN1M8	2
34	Upset Bolt	CUSM6X10S2	CUSM8X12S2	1
35	Name Plate	IRB5114DN	KRB5114DN	1
36	Plain Washer	PWM8M	PWM8M	1
37	Nylon Nut	HNN1M8	HNN1M8	1
38*	Chain Fastening Bolt	IRB4124T	KHH5048T	1
39	Cross Recessed Head Bolt	CBM5X25B3	CBM5X25B3	2

†Specify the lift when placing an order for Load Chain.

* Includes Nut and Bolt.

NOTE: When ordering spare parts please have Model, Capacity, Product Number and Quantity available.

Figure 16 - 3 & 6 Ton Models

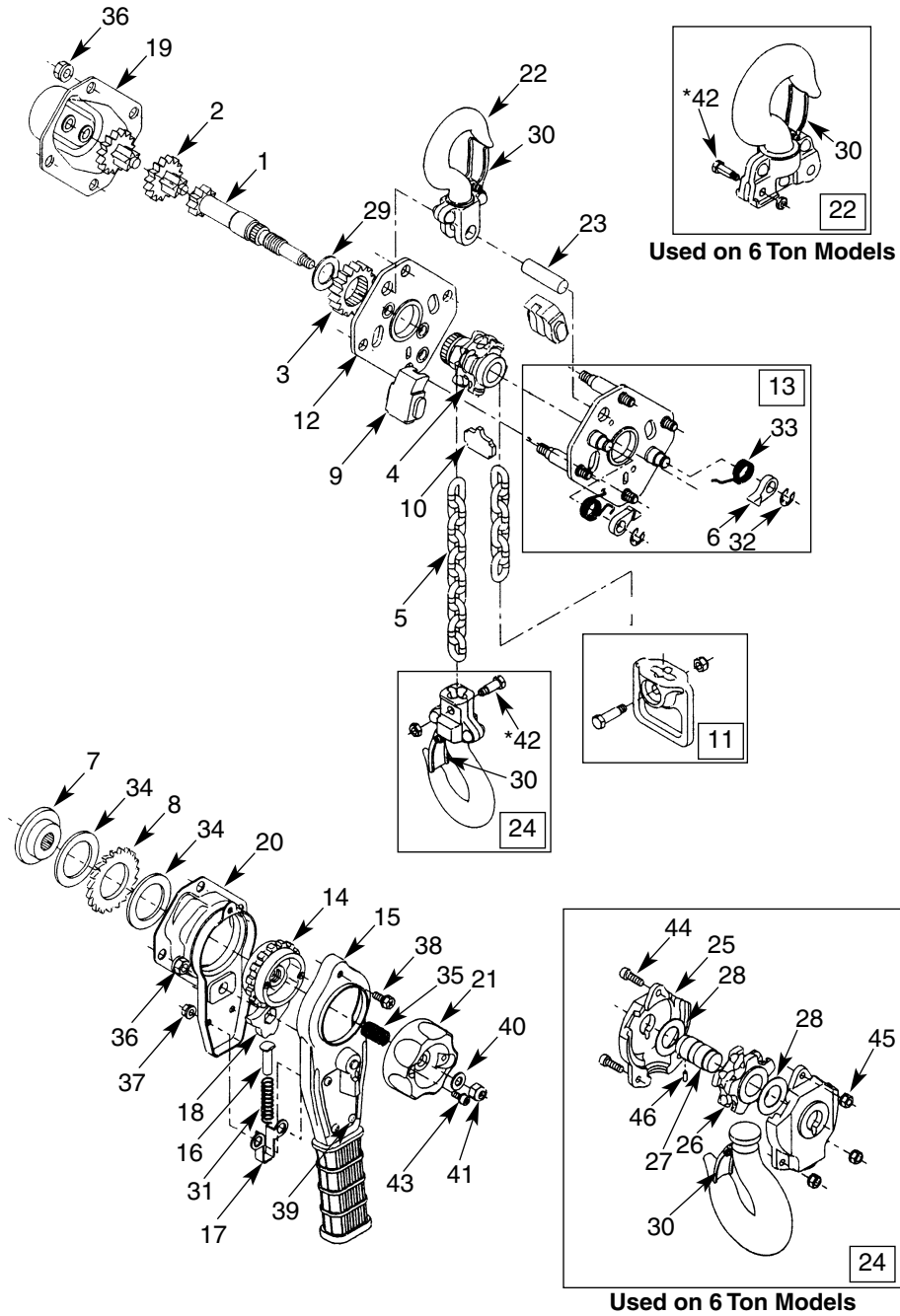

Ref. No.	Description	3 Ton Part No.	6 Ton Part No.	Qty
1	Pinion Shaft	NRB5001	NRB5001	1
2	Pinion with Pinion Gear	NRB5002T	NRB5002T	2
3	Load Gear	NRB5004	NRB5004	1
4	Load Sheave	NRB5005	NRB5005	1
†5	Load Chain	V9	V9	1
6	Pawl	KRB5007	KRB5007	2
7	Disc Hub	KRB5008	KRB5008	1
8	Ratchet Wheel	KRB5009	KRB5009	1
9	Chain Guide	NRB5012	NRB5012	2
10	Stripper	NRB5015	NRB5015	1
11	Stop Grip	NRB40062T	NRB40062T	1
12	Gear Side Plate	NRB5018T	NRB5018T	1
13	Handle Side Plate	NRB5020U	NRB5020U	1
14	Disc Nut	KRB5023	KRB5023	1
15	Operating Handle	KRB5024T	KRB5024T	1
16	Spring Shaft	IRB3030	IRB3030	1
17	Shaft Base	IRB3031	IRB3031	1
18	Handle Pawl	KRB5032	KRB5032	1
19	Gear Cover	NRB5037	NRB5037	1
20	Ratchet Cover Assembly	NRB5040	NRB5040	1
21	Guide Handle	IRB5042	IRB5042	1
22	Top Hook Assembly	NRB5048U	QRB5048U	1
23	Yoke Pin	NRB5051	NRB5051	1
24	Bottom Hook Assembly	NRB5053U	QRB5053U	1
25	Load Block Frame	-	QRB50533	2
26	Idle Sheave	-	QRB5055	1
27	Wheel Pin	-	QRB5056	1
28	Collar for Idle Sheave	-	HH4100083	2
29	Collar for Pinion Shaft	NRB5059	NRB5059	1
30	Hook Latch Assembly	KRB5074T	PRB5074T	2
31	Change Over Spring	IRB3116	IRB3116	1
32	E-Ring	SRE9	SRE9	2
33	Pawl Spring	NRB5104	NRB5104	2
34	Brake Lining	KRB5105	KRB5105	2
35	Free-Chaining Spring	NRB5106	NRB5106	1
36	Spring Nut	HSN1M10	HSN1M10	8
37	Spring Nut	HSN1M8	HSN1M8	2
38	Upset Bolt	CUSM8X12S2	CUSM8X12S2	1
39	Name Plate	NRB5114DN	QRB5114DN	1
40	Plain Washer	PWM8M	PWM8M	1
41	Nylon Nut	HNN1M8	HNN1M8	1
42*	Chain Fastening Bolt	NRB4124T	NRB4124T	1
43	Cross Recessed Head Bolt	CBM5X25B3	CBM5X25B3	2
44	Hexagonal Socket Head Bolt	-	CBM10X35	3
45	Spring Nut	-	HSNM10	3
46	Knock Pin	-	NP6X10	1

†Specify the lift when placing an order for Load Chain.

* Includes Nut and Bolt.

NOTE: When ordering spare parts please have Model, Capacity, Product Number and Quantity available.

High Performance Lifting

COFFING[®] **HOISTS**



WARRANTY

Every hoist is thoroughly inspected and performance tested prior to shipment from the factory. If any properly installed, maintained and operated hoist as outlined in the applicable accompanying Coffing Hoists manual develops a performance problem due to defective materials or workmanship as verified by Coffing Hoists, repair or replacement of the hoist will be made to the original purchaser without charge and the hoist will be returned, transportation prepaid. This warranty does not apply where deterioration is caused by

normal wear, abuse, improper or inadequate power supply, improper or inadequate maintenance, eccentric or side loading, overloading, chemical or abrasive actions, excessive heat, unauthorized modifications or repairs, or use of non-Coffing repair parts. **EXCEPT AS STATED HEREIN, COFFING HOISTS MAKES NO OTHER WARRANTIES, EXPRESS OR IMPLIED, INCLUDING WARRANTIES OF MERCHANTABILITY AND FITNESS FOR A PARTICULAR PURPOSE.**

⚠ WARNING

Overloading and Improper Use Can Result In Injury

TO AVOID INJURY:

- Do not exceed working load limit, load rating, or capacity.
- Do not use equipment to lift people or loads over people.
- Use only alloy chain and attachments for overhead lifting.
- Read and follow all instructions.

Certification Statement

This is to certify that the accompanying Coffing Hoist(s) has (have) been tested at 125% of rated capacity and inspected in accordance with ASME/ANSI B30.16 or B30.21. Do not exceed rated capacity stated on the hoist. Refer to manual for operating instructions and forward manual to operator.

Coffing Hoists • Country Club Road • P.O. Box 779 • Wadesboro, North Carolina 28170 USA

LSB-B-680

©2002 Coffing Hoists

Distributed by Tri-State Equipment Company Inc.
sales@tsoverheadcrane.com
www.tsoverheadcrane.com
Tel: (314) 869-7200